

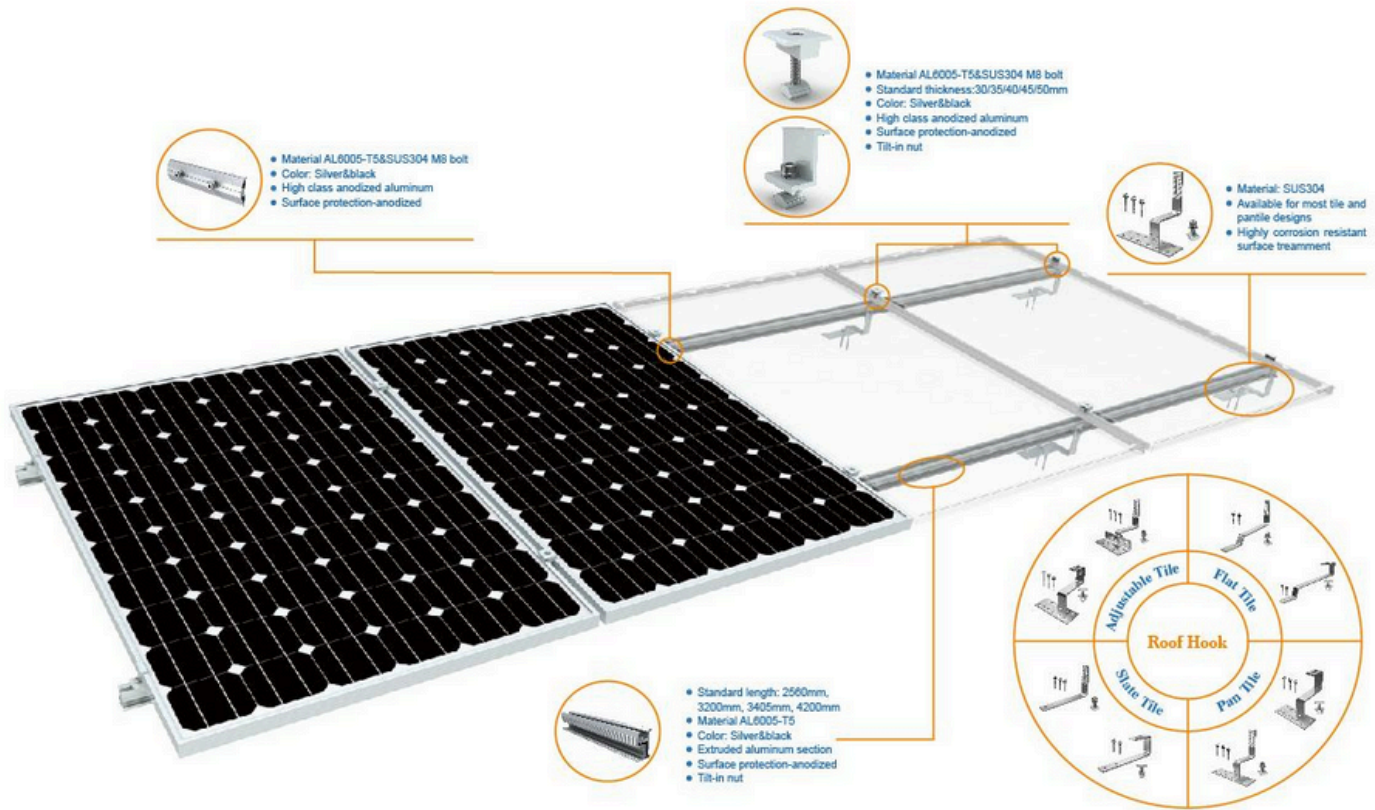

**SUNENERGY SAVING
SOLUTION**

GRAPHIC

Systemes de fixation pour panneaux solaires



+212-646-117-689
+212-663-284-342
www.sunenergy.ma



SUNENERGY SAVING
SOLUTION

Rails Galvanisee

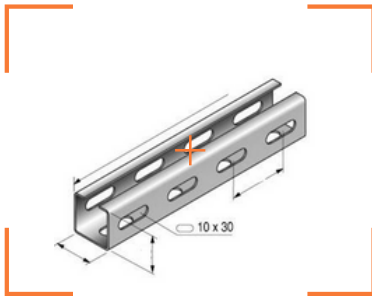

1	Profile	41/41 mm
2	Materieu	acier
3	revitement	Galva

Clamps Middle & End

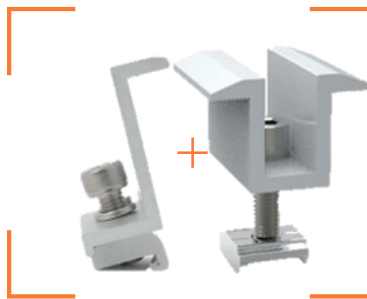

1	Clamps	41/41 mm
2	Materieu	Aluminium
3	Installation facile	

Pièce de connexion



1	Rôle	Jumelage, inclinaison et Pied
2	Materieu	Acier
3	Revêtement	Galva



FACILE À INSTALLER



MONTAGE SANS SOUDURE



ROBUSTE



GAIN DE TEMPS



MOIN PERÇAGE



SUNENERGY SAVING
SOLUTION

Structure une seule ligne : L1B1

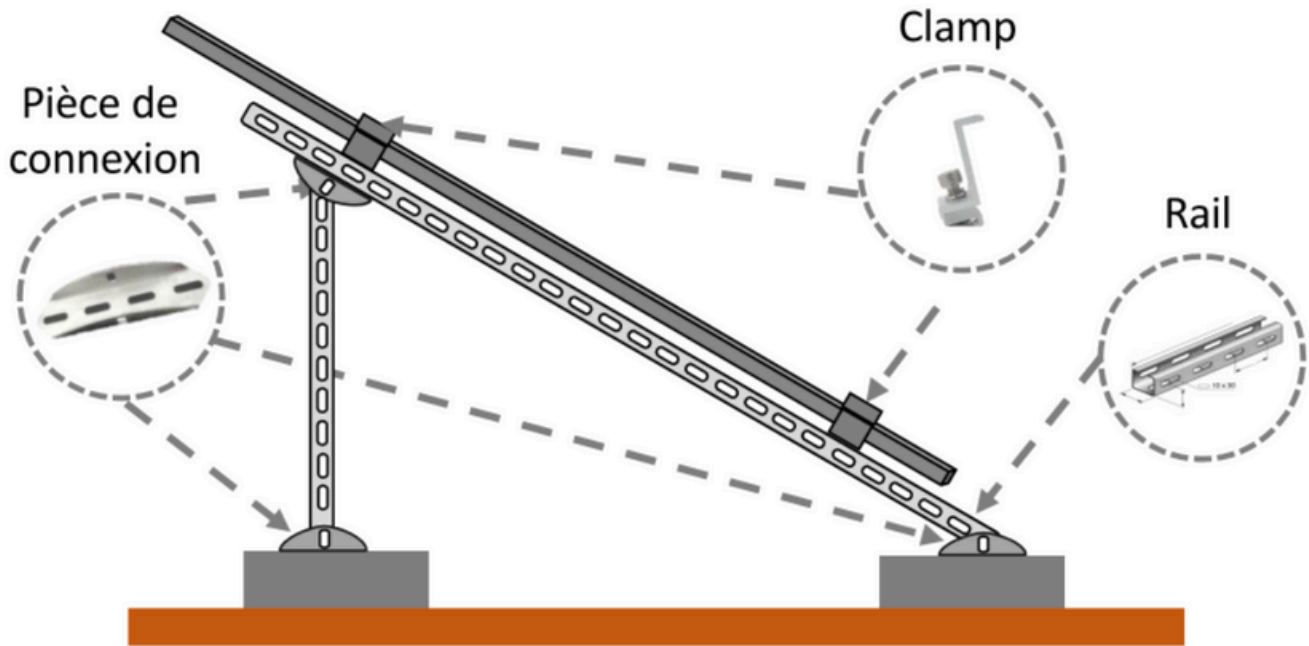
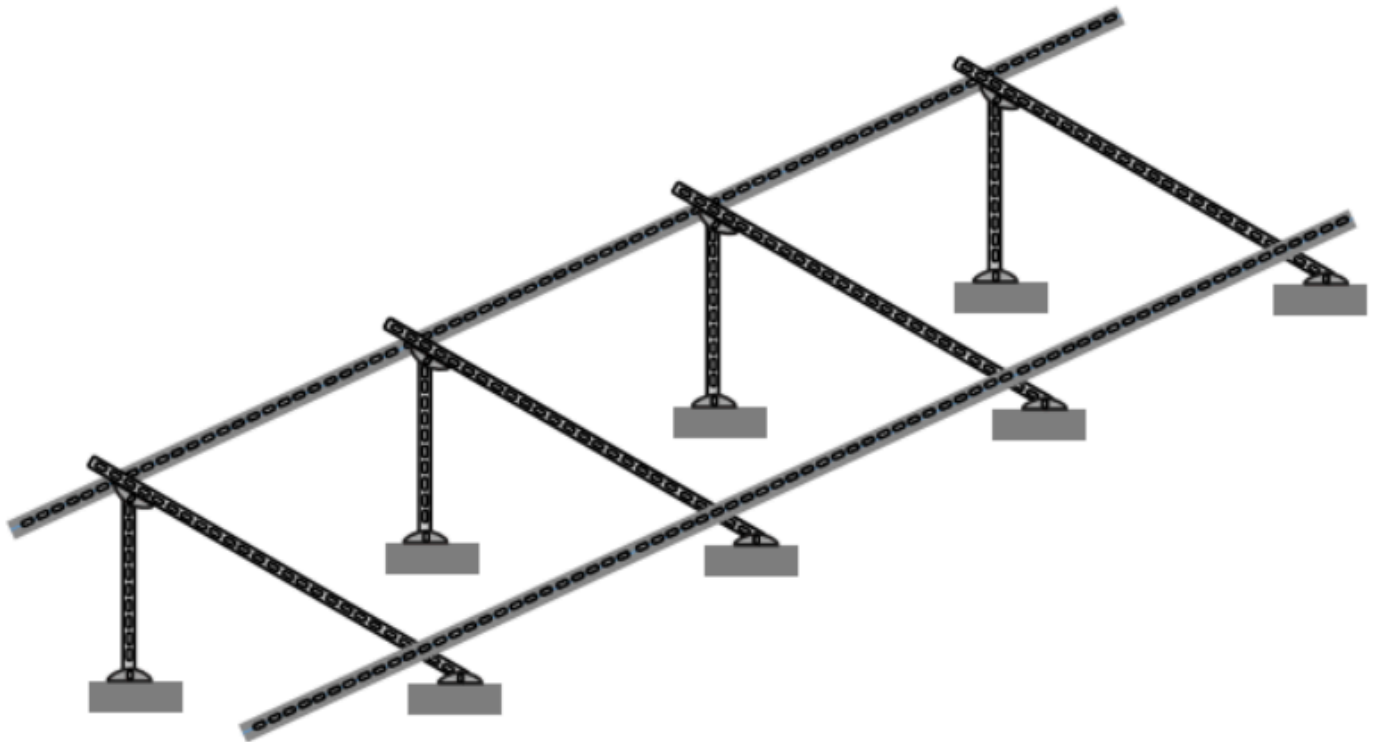



SUNENERGY SAVING
SOLUTION

Structure une seule ligne : L1B2

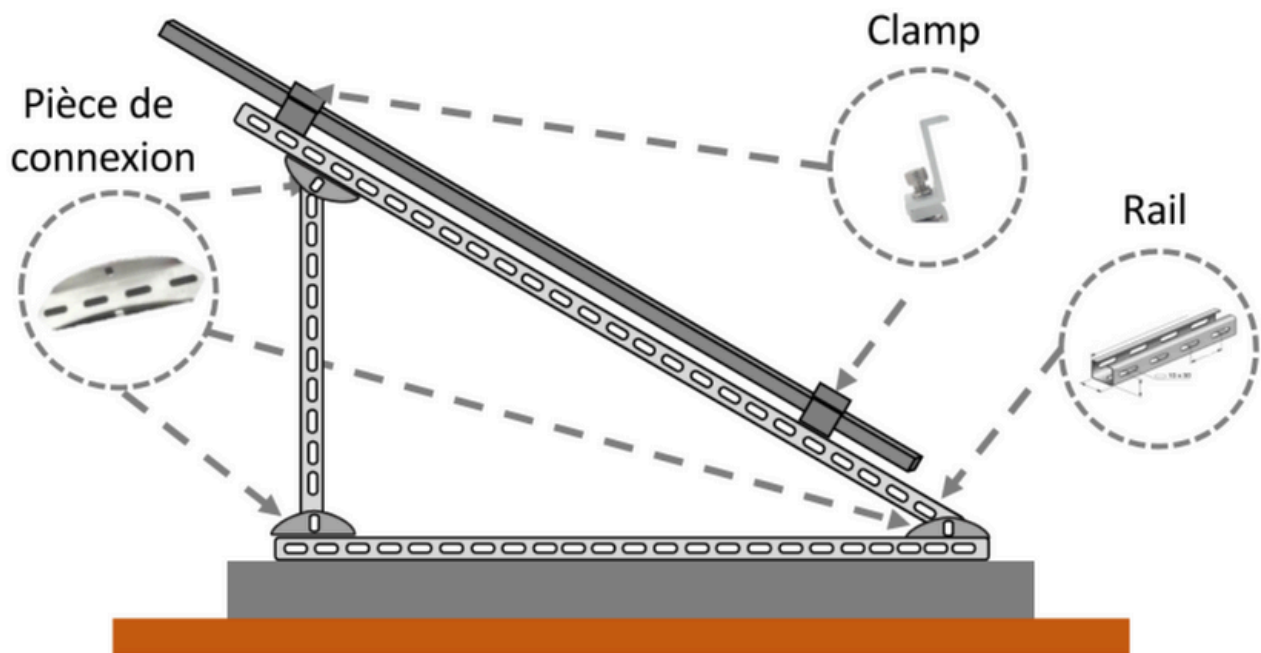
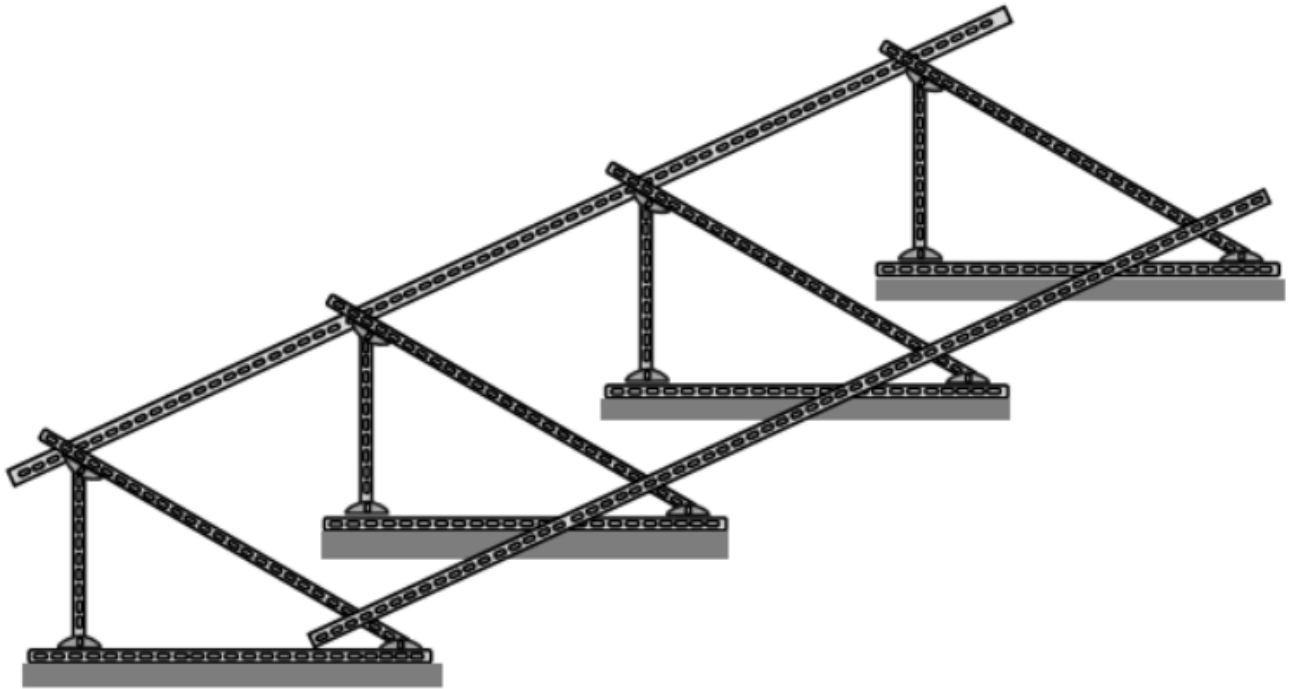



SUNENERGY SAVING
SOLUTION

Structure une seule ligne : L1B3

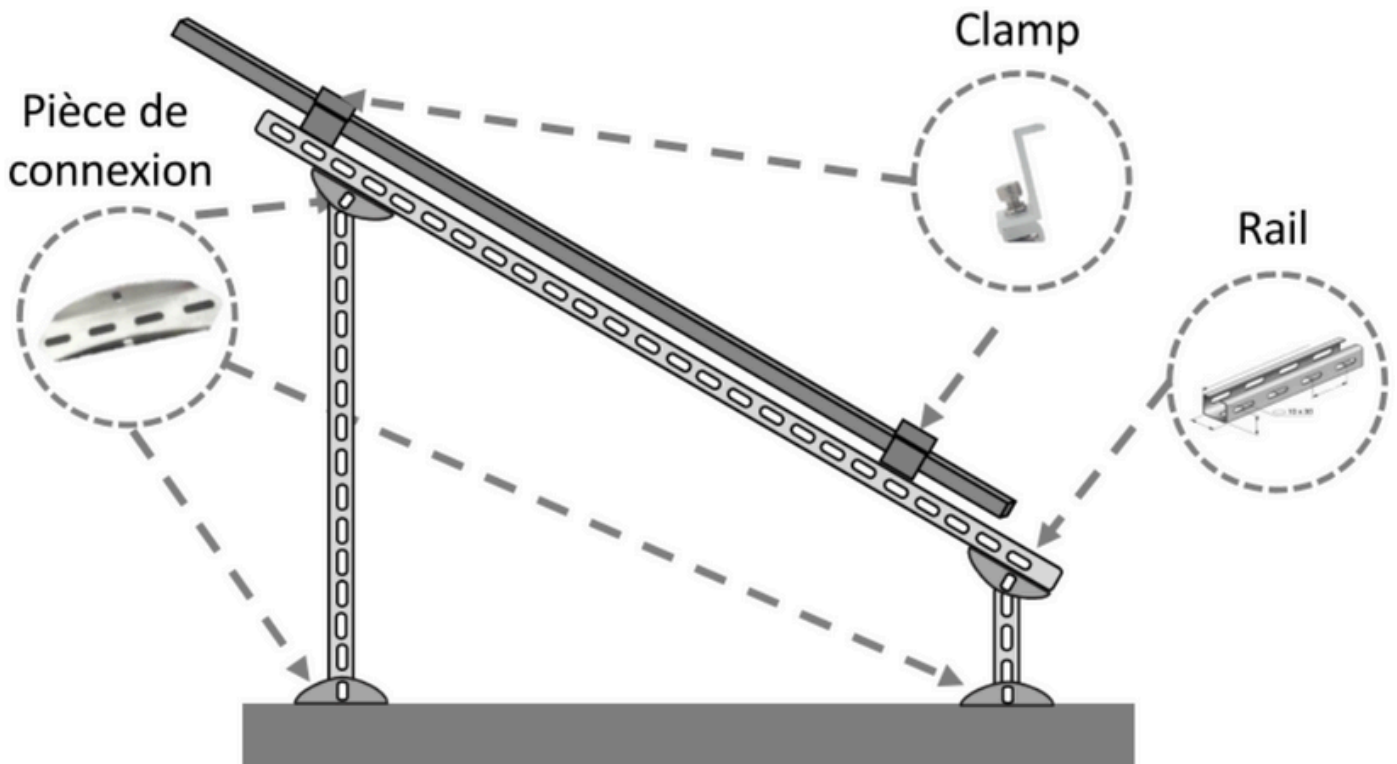
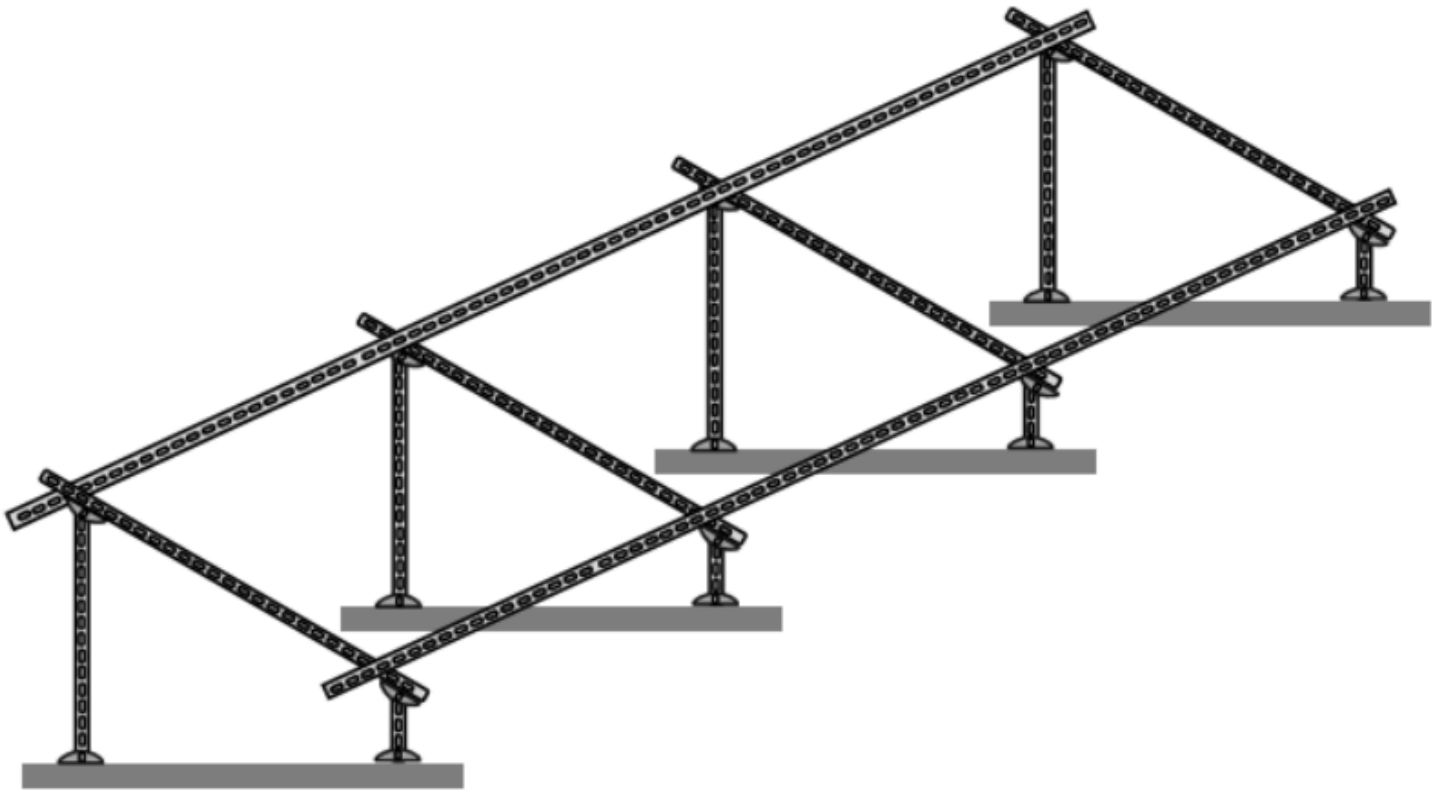



SUNENERGY SAVING
SOLUTION

Structure deux ligne : L2B1

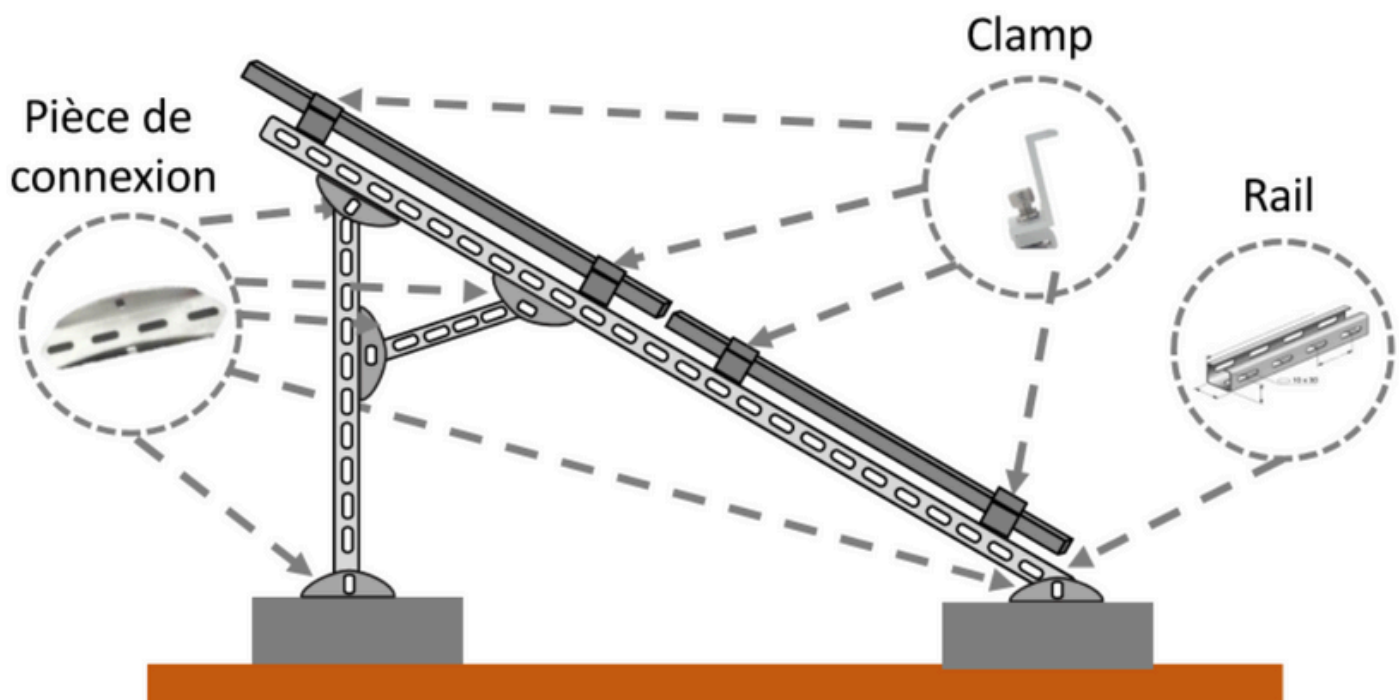
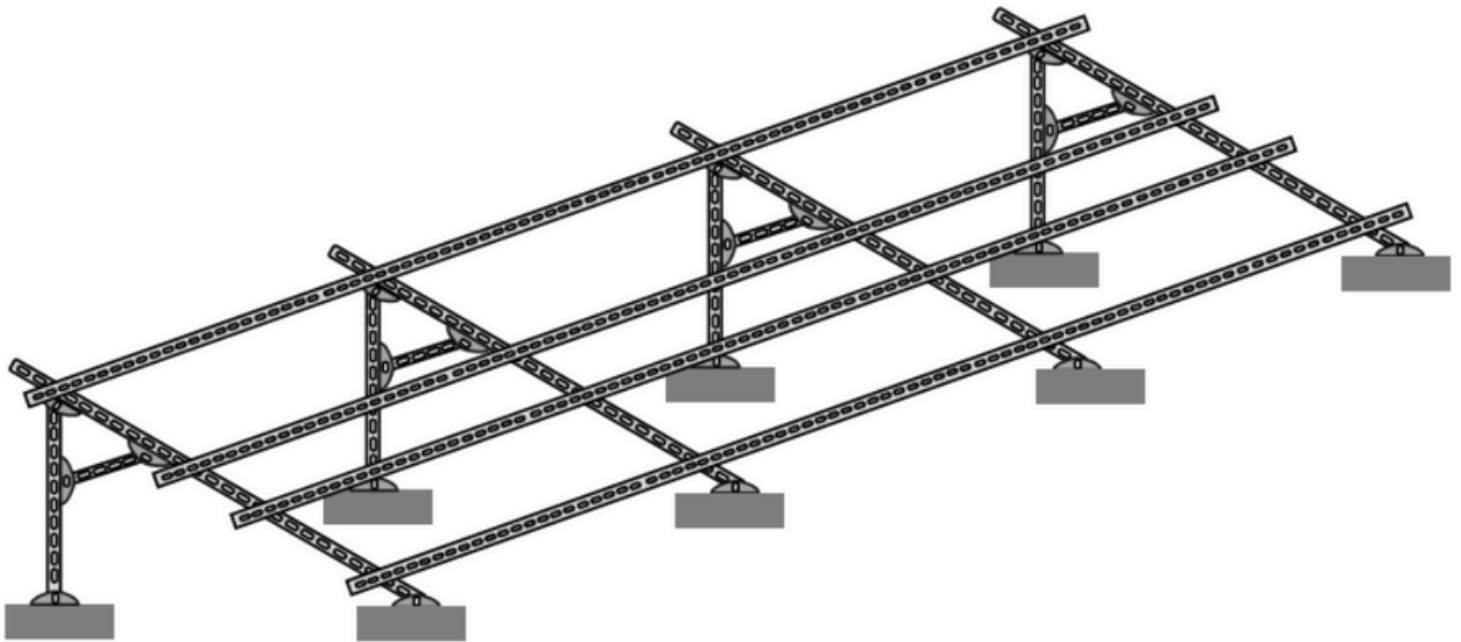



SUNENERGY SAVING
SOLUTION

Structure deux ligne : L2B2

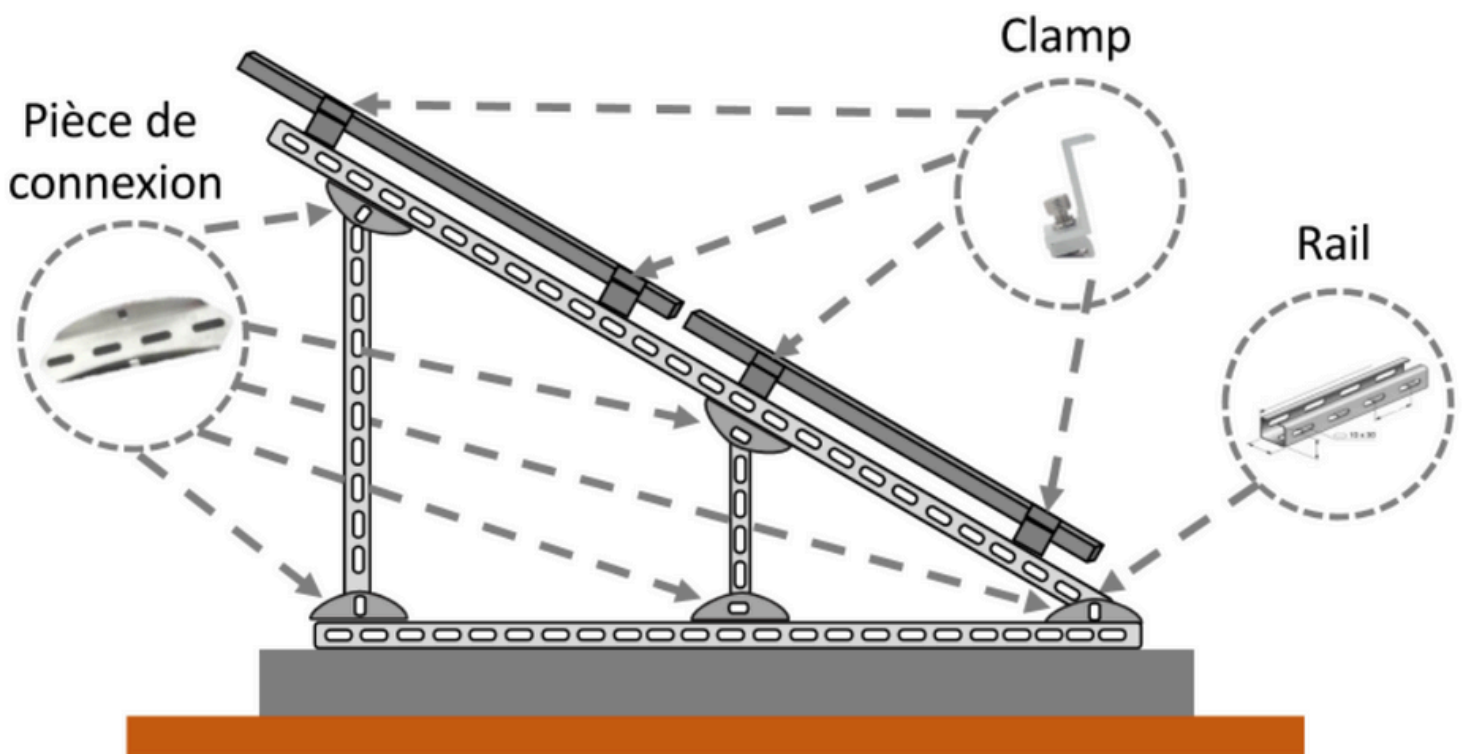
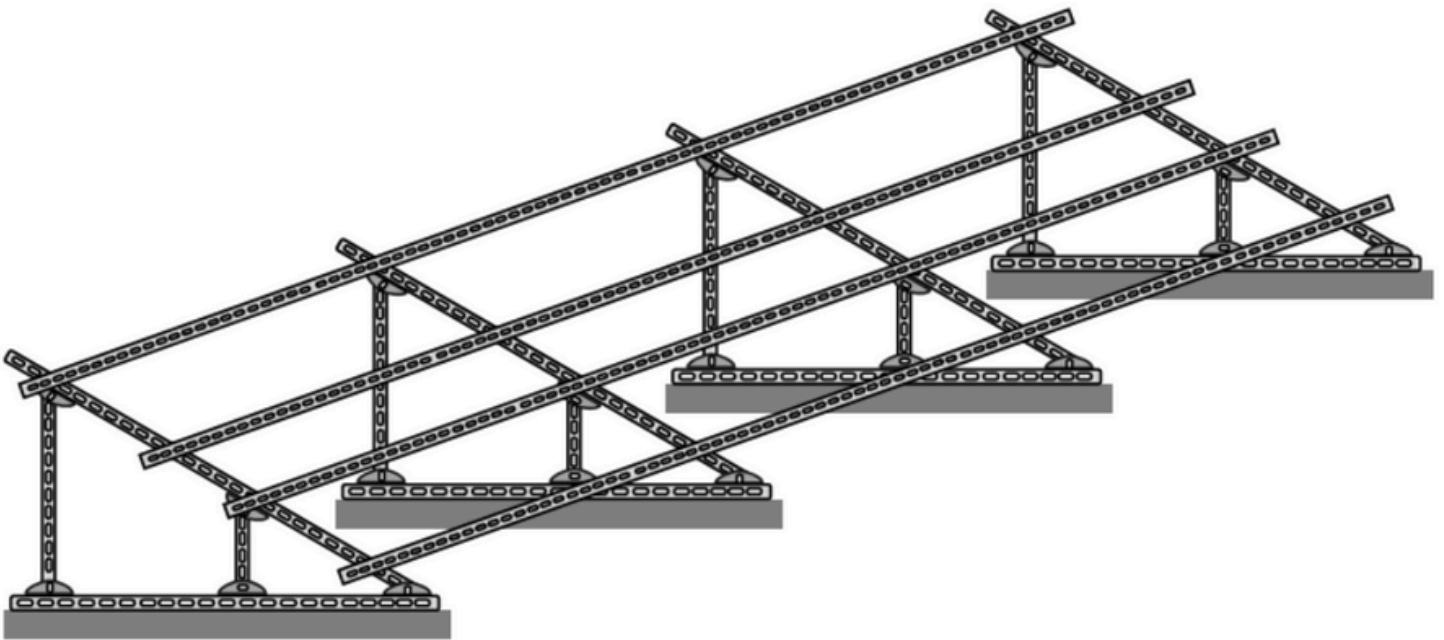



SUNENERGY SAVING
SOLUTION

Structure deux ligne : L2B3

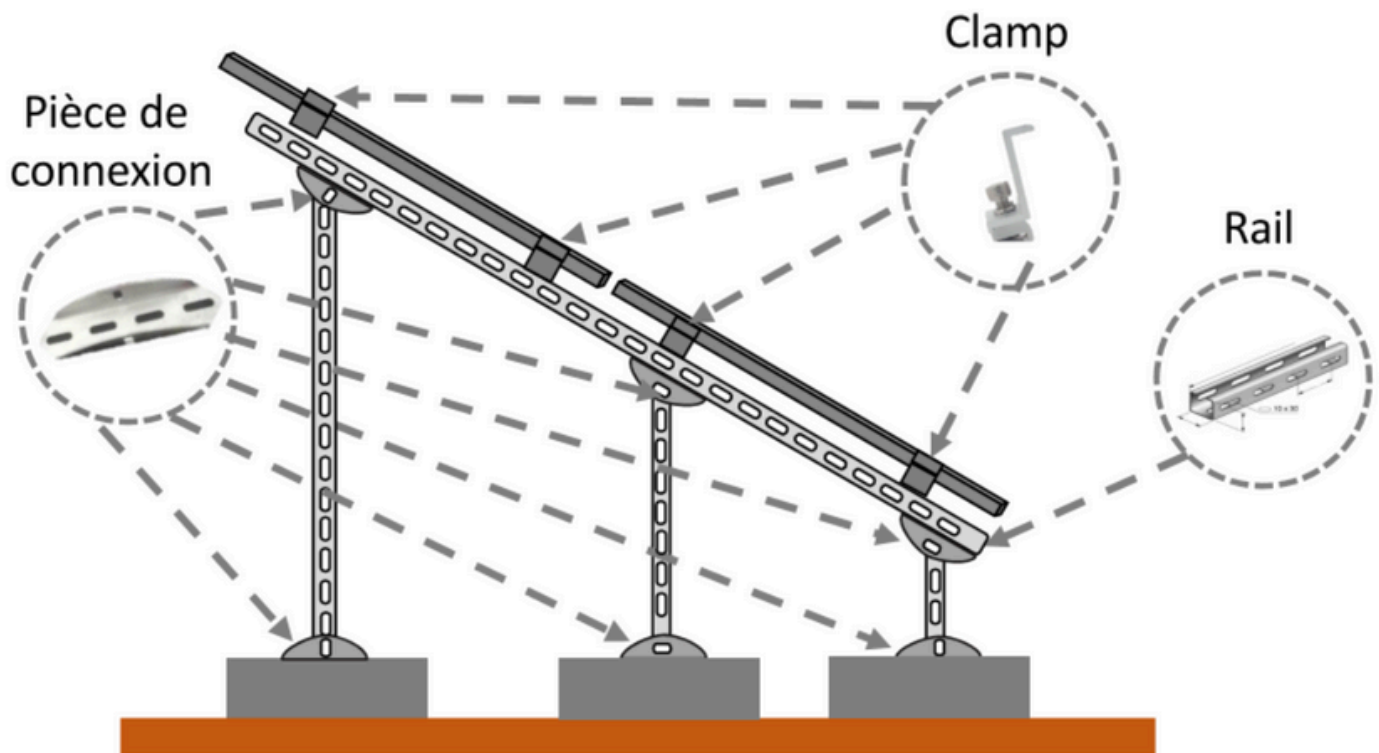
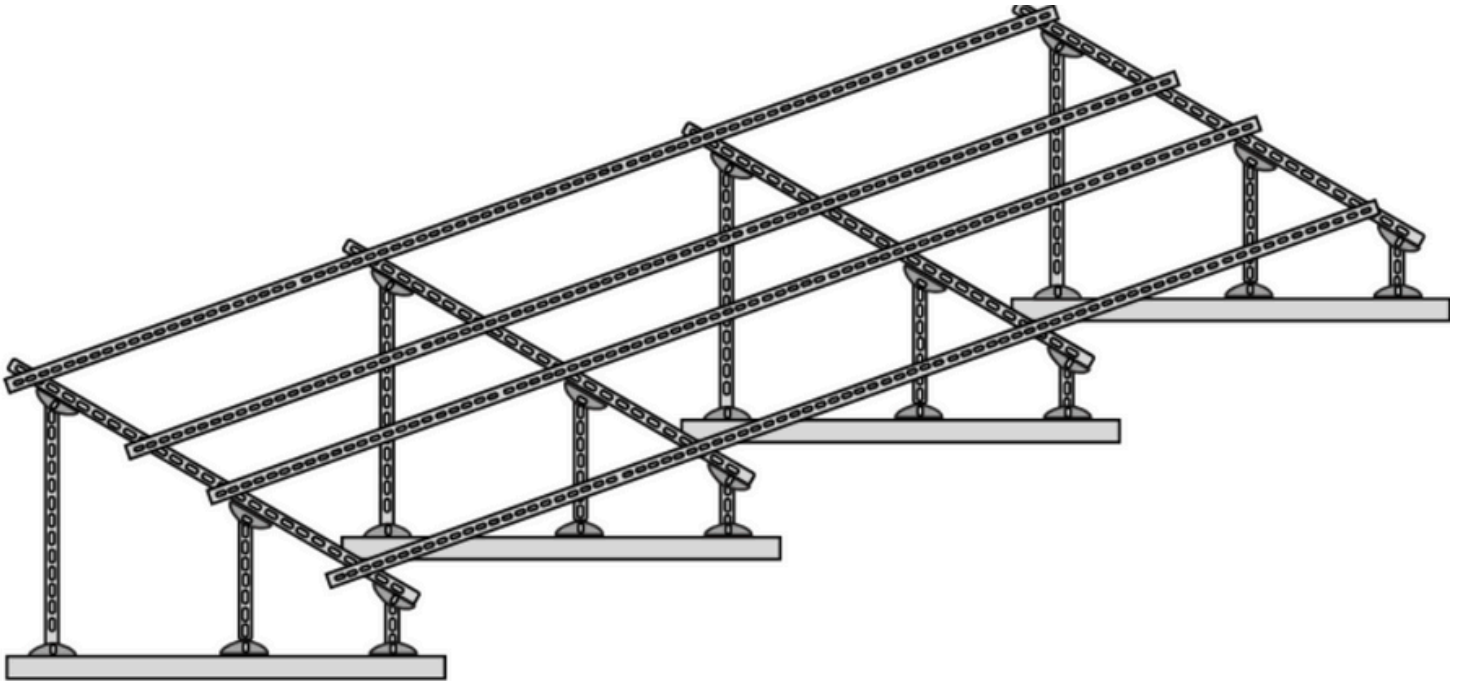



SUNENERGY SAVING
SOLUTION

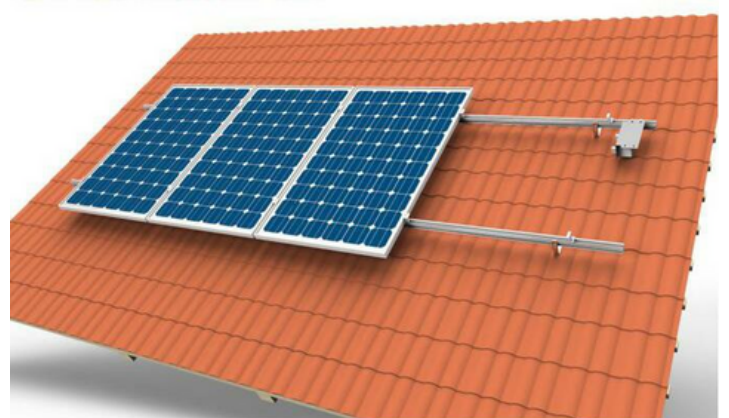



SUNENERGY SAVING
SOLUTION

